

TURBOWAVE

PROFESSIONAL COUNTERTOP ELECTRIC OVEN

INSTRUCTION MANUAL



ELECTRIC OVEN

TT-EVS38





IMPORTANT SAFETY INSTRUCTIONS

When using your *Electric Oven*, basic safety precautions should always be observed, including the following:

1. Read all instructions.

- Do not** touch hot surfaces, use handles or knobs.
- To protect against electric shock, do not immerse cord, plug or any parts of the oven in water or any other liquids.
- Do not** let cord hang over edge of table or counter, or touch hot surfaces.
- Do not** operate appliance with damaged cord or plug or after the appliance malfunctions or has been damaged in any manner. Return appliance to the nearest authorized service facility for examination, repair or adjustment.
- The use of accessory attachments not recommended by the appliance manufacturer may cause hazard or injury.
- Do not** place on or near a hot gas or electric burner.
- Unplug from outlet when not in use and before cleaning. Allow to cool before putting on or taking off parts, and before cleaning.
- To disconnect, turn the timer to OFF, then remove the plug. Always hold the plug, and never pull the cord.
- Do not** cover crumb tray or any part of the oven with metal foil. This may cause the oven to overheat.
- Use extreme caution when removing the tray, racks or disposing of hot grease or other hot liquids.
- Do not** clean the inside of the oven with metal scouring pads, pieces can break off the pad and touch electrical parts, creating a risk of electric shock.
- Oversized foods or metal utensils must not be inserted in a electric oven as they may create a fire or risk of electric risk.
- A fire may occur if the oven is covered or touching flammable material, including the curtains, draperies, walls, and the like, when in operation. Do not store any item on top of the appliance when in operation.
- Extreme cautions should be exercised when using cooking or baking containers constructed of anything other than metal or ovenproof glass.
- Be sure that nothing touches the top or bottom elements of the oven.
- Do not** place any of the following materials in the oven: cardboard, plastic, paper, or anything similar.
- Do not** store any materials other than manufacturer's recommended accessories in this oven when not in use.
- Always wear protective, insulated oven gloves or use a special handle when inserting or removing items from the hot oven
- This appliance has a tempered, safety glass door. The glass is stronger than ordinary glass and more resistant to breakage. Tempered glass can still break around edges. Avoid scratching door surface or nicking edges.
- Do not** use outdoors.
- Do not** use appliance for other than intended use.
- The appliance can be used by children aged from 8 years and above and persons with reduced physical

sensory or mental capabilities or lack of experience and knowledge if they have been given supervision or instruction concerning use of the appliance in a safe way and understand the hazards involved.

24. Children shall not play with the appliance.

25. Cleaning and user maintenance shall not be made by children unless they are old than 8 and supervised.

26. Keep the appliance and its cord out of reach of children less than 8 years.

27. If the supply cord is damaged, it must be replaced by the manufacturer, its service agent or similarly qualified persons in order to avoid a hazard.

28. This appliance is not intended for use by persons (including children) with reduced physical sensory

or mental capabilities, or lack of experience and knowledge, unless they have been given supervision or instruction concerning use of the appliance by a person responsible for their safety.

29. Children should be supervised to ensure that they do not play with the appliance.

30. The temperature of accessible surfaces may be high when the appliance is operating.

31. The appliances are not intended to be operated by means of an external timer or separate remote-control system.

32. The rear surface of appliances which, according to the instructions, shall be placed against a wall, and are not accessible with test probe 41 of EN610

GETTING TO KNOW YOUR NEW OVEN

MAIN COMPONENT: (Product may vary slightly from what is illustrated)

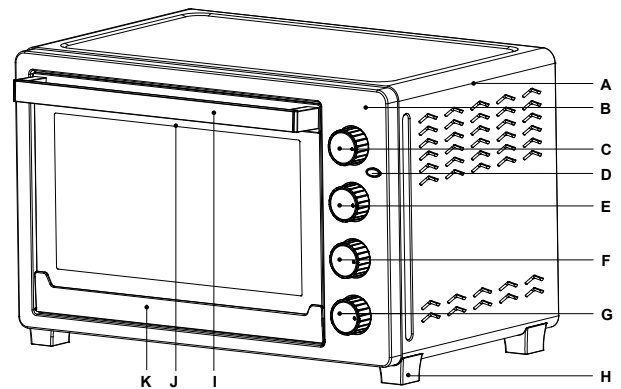
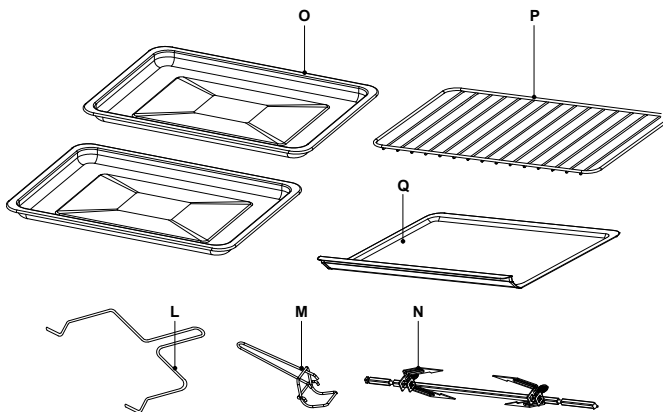

- A: Housing
- B: Front frame
- C: Convection & rotisserie control knob
- D: Power indicator light
- E: Temperature control knob
- F: Function control knob
- G: Timer knob
- H: Oven foot
- I: Door handle

- J: Glass door
- K: Lower door frame
- L: Rotisserie handle
- M: Tray handle
- N: Rotisserie set
- O: Bake tray
- P: Wire rack
- Q: Crumb Tray

TECHNICAL SPECIFICATIONS

Voltage: 220-240V~50/60Hz
Power: 2000W
Capacity: **38 Liters**

BEFORE USING YOUR OVEN





Before using your electric oven for the first time, be sure to:

1. Read all of the instruction included in this manual.
2. Make sure that the oven is unplugged and the **Timer Knob** is in the “OFF” position.
3. Wash all the accessories in hot, soapy water or in the dishwasher.
4. Thoroughly dry all accessories and re-assemble in oven, plug oven into outlet and you are ready to use your new oven.
5. After re-assembling your oven, we recommend that you run it at the highest temperature (230°C) on the **Toast Function** () for approximately 15 minutes to eliminate any packing residue that may remain after shipping. This will also remove all traces of odor initially present.

Please Note: Initial start-up operation may result in minimal smell and smoke (about 15 minutes). This is normal and harmless. It is due to burning of the protective substance applied to the heating elements in the factory.

Please familiarize yourself with the following oven functions and accessories prior to first use:

● **Convection & Rotisserie Control:** Choose convection fan working () or rotisserie motor working (), or convection fan & rotisserie motor working together (), they can work with bake, broil or toast function separately.

● **Temperature Control:** choose the desired temperature from **100°C** to **230°C** for cooking.

● **Function Control:** There are 3 function selection and 4 rack positions inside the oven for a variety of cooking needs;

Broil (): Only upper heating elements work, suitable for broiling fish, steak, poultry, pork chops, etc.

Bake (): Only lower heating elements work, suitable for baking cakes, pies, cookies etc. food that don't need browning or crispy surface, or stewing food in a pot.

Toast (): Both upper and lower heating elements work together, suitable for toasting bread, muffins, frozen waffles, pizza, etc.

- **Timer Control:** You could choose up to 60 minutes for cooking. Time can be adjusted during cooking procedure. There is a bell ring at the end of the programmed time.
- **Power “ON” indicator light:** It’s illuminated whenever the timer is turned on.
- **Oven Lamp:** It’s illuminated when the timer is turned on, convenient for observing the cooking procedure.
- **Bake Tray:** For use in broiling and roasting meat, poultry, fish and various other foods. Also, to be used as a drip pan to catch the oil drippings.
- **Wire Rack:** For toasting, baking, and general cooking in casserole dishes and standard pans.
- **Tray Handle:** Allows you to pick up the wire rack, and bake tray when they are hot.
- **Rotisserie Set:** For fixing a whole chicken, fish, or a large piece of meat when using rotisserie function.
- **Rotisserie Handle:** Allows you to take off the rotisserie set and cooked food from inside oven after cooking.
- **Crumb Tray:** Allows you to collect the residue of toast, pizza, cake etc or meat oil drippings.



WARNING: TO AVOID RISK OF INJURY OR BURNS,
DO NOT TOUCH HOT SURFACES WHEN OVEN IS IN USE.
ALWAYS USE OVEN MITTS.



CAUTION: Always use extreme care when removing bake tray, wire rack or any hot container from a hot oven. Always use the tray handle, or an oven mitt when removing hot items from the oven.

HOW TO USE CONVECTION

Convection cooking combines hot air movement by means of a fan blowing with the regular features (broil, bake and toast). Convection cooking provides faster cooking in many cases than regular radiant type toaster oven. The fan gently sends hot air to every area of the food, quickly browning, crisping and sealing in moisture and flavor. It produces more even temperature all around the food by hot air movement, so that food

cooks/bakes/broils evenly versus the normal ovens hot and cold spots. The convection feature allows cooking/baking at lower temperatures, which saves energy and helps keep the kitchen cooler. Convection air is superheated and it circulates around the food so it cooks food significantly faster than conventional ovens.

The convection fan works when you turn the first knob to **Convection Function** ()

or **Convection & Rotisserie Function** (),

it can work with broil, bake or toast function separately.

HOW TO USE ROTISSERIE

We recommend that you do not cook a roast larger than 4-5 lbs. on the rotisserie set. Chicken should be bound in a string to prevent the chicken legs or wings from unraveling during roasting so that rotisserie assembly will rotate smoothly. For best results we recommend that you preheat the oven for **15 minutes** on **230°C**.

OPERATION:

- Insert the meat or poultry that you are going to cook onto the rotisserie set. Making sure that the meat or poultry is secured tightly with the skewer clamps and thumbscrews. Make sure that the meat or poultry is centered onto the skewer.
- Insert the pointed end of the rotisserie skewer into the drive socket located on the right-hand side of the oven wall. Make sure that the square end of the rotisserie skewer rests on the rotisserie skewer support located on the left-hand side of the oven wall.
- Slide the bake tray onto the lowest position to catch possible food drippings.
- Turn the temperature control knob to your desired temperature.
- Turn the first knob to **Rotisserie Function** () or

Convection Rotisserie Function ()

- Turn the third function knob to **Broil Function** ()
- Make sure the crumb tray is put at the bottom of the oven cavity.
- Turn the timer knob to your desired cooking time.
- When the cooking is completed, the oven bell will ring; turn the first and third knob to "OFF".
- Remove the rotisserie set from the oven by placing the hooks of the rotisserie handle under the grooves on either side of the rotisserie set, lift the left side of the rotisserie set first by lifting it up and out. Then pull the rotisserie set out of the drive socket and carefully remove the roast from the oven.
- Take the meat or poultry off the rotisserie skewer and place on a cutting board or platter.

HOW TO USE BROIL

For best results, it is recommended that you preheat the oven for 15 minutes on 230°C.

Operation

- Place food on the wire rack and slide into the top rack position. Food should be placed as close as possible to the top heating element without touching it.
- Put bake tray at the lowest rack position to catch possible dripping.
- To prevent fire hazards, it is suggested to wrap food with aluminum foil
- Set temperature knob to appropriate temperature.
- Brush food with sauces or oil, as desired.
- Set function knob to **Broil Function.** ()
- Turn time knob to your desired cooking time.
- Turn food over midway through the prescribed cooking time.
- When broiling is complete, turn the third knob to “OFF” position.

HOW TO USE BAKE

Please note that the BAKE function uses only the bottom heating elements. For best results, it is recommended that you preheat the oven for 15 minutes on 230°C.

OPERATION:

- Place food on the wire rack or bake tray and slide into the lowest rack position.
- To prevent fire hazards, it is suggested to wrap food with aluminum foil
- Set temperature knob to appropriate temperature.
- Brush food with sauces or oil, as desired.
- Set function knob to **Bake Function.** ()
- Turn time knob to your desired cooking time.
- Turn food over midway through the prescribed cooking time.
- When baking is complete, turn the third knob to “OFF” position.

Positioning of the Wire Racks

Cookies – Use bottom and middle Support Guides.

Layer Cakes – Use bottom Support Guide only (bake one at a time).

Pies – Use bottom and middle Support Guides.

HOW TO USE TOAST

Please note that the TOAST function uses all the heating elements. Large capacity oven allows for toasting 4 to 6 slices of bread, 6 muffins, frozen waffles or frozen pancakes. When toasting only 1 or 2 items, place food on the bake rack in the center of the oven.

OPERATION:

- Place food on the wire rack and slide into the middle rack position.
- Set temperature knob to appropriate temperature.
- Set function knob to **Toast Function**. ()
- Make sure the crumb tray is placed at the bottom of inside oven.
- Turn time knob to your desired cooking time.
- When toast is completed, bell will ring to signal the end of the toast cycle.
- Turn the function knob to "OFF" position.

Note: Wire Rack should be positioned in the middle of the oven with the indentations pointing down.

CLEANING & MAINTENANCE

Clean the appliance every time after use.

1. Remove the plug from the wall socket and allow the appliance to cool down completely.
2. Use warm water with a small amount of washing-up liquid to clean the baking tray, the grille and the removal tool. Rinse the items with plenty of water and dry them thoroughly.
3. Use a damp cloth to clean the interior and exterior of the oven and the door. Dry them thoroughly.
4. Place all the items back in the oven and store the oven
 - Make sure the plug has been removed from the plug socket before cleaning the appliance.
 - Never use corrosive or scouring cleaning agents or sharp objects (such as knives or hard brushes) to clean the appliance.
 - Never immerse the appliance, the power cord or the plug in water or any other fluid.

DISPOSAL OF OLD ELECTRICAL APPLIANCES:



The European directive 2002/96/EC on Waste Electrical and Electronic Equipment (WEEE), requires that old household electrical appliances must not be disposed of in the normal unsorted municipal waste stream. Old appliances must be collected separately in order to optimize the recovery and recycling of the materials that they contain and reduce the impact on human health and the environment.

The crossed out "wheeled bin" symbol on the product reminds you of your obligation, that when you dispose of the appliance, it must be separately collected.

Consumers should contact their local authority or retailer for information concerning the

correct disposal of their old appliance.

LIMITED WARRANTY:

Limited Warranty applies to purchases made from authorized retailers of **TurboTronic®**.

TurboTronic® Warranty coverage applies to the original owner and to the original product only and is not transferable.

TurboTronic® warrants that the unit shall be free from defects in material and in workmanship. The Limited Warranty applies only when the unit is used under normal household conditions and maintained according to the requirements stated in the Owner's Guide, subject to the following conditions and exclusions:

ANY WARRANTY OR AFTER PURCHASE SERVICE, SHOULD BE WITH THE THIRD-PARTY COMPANY, FROM WHICH YOU PURCHASED THE PRODUCT. TURBOTRONIC® PROVIDES THE WARRANTY ONLY TO OUR THIRD-PARTY SUPPLIERS. SINCE THIS PRODUCT WAS NOT PURCHASED DIRECTLY FROM TURBOTRONIC® BUT VIA ONE OF OUR THIRD-PARTY SUPPLIERS, ANY ISSUE AFTER THE PURCHASE, CUSTOMER SERVICE OR RECEIVING THE WARRANTY, SHOULD BE ONLY / DIRECTLY HANDLED VIA THE THIRD-PARTY SUPPLIER FROM WHICH YOU PURCHASED THE PRODUCT.

What is covered by this warranty?

1. The original unit and/or non-wearing parts deemed defective will be repaired or replaced, at **TurboTronic®** sole discretion.
2. **TurboTronic®** reserves the right to replace the unit with one of equal or greater value.

What is not covered by this warranty?

1. Normal wear and tear of wearing parts (such as blending vessels, lids, cups, blades, blender bases, removable pots, racks, pans, etc.), which require regular maintenance and/or replacement to ensure the proper functioning of your unit, are not covered by this warranty.
2. Any unit that has been tampered with or used for commercial purposes.
3. Damage caused by misuse, abuse, negligent handling, failure to perform required maintenance (e.g., failure to keep the well of the motor base clear of food spills and other debris), or damage due to mishandling in transit.
4. Consequential and incidental damages.
5. Defects caused by repair persons not authorized by **TurboTronic®**. These defects include damage caused in the process of shipping, alteration, or repair of the **TurboTronic®** product (or any of its parts) when the repair is performed by a repair person not authorized by **TurboTronic®**.
6. Products purchased, used, or operated outside Europe.

Illustrations may differ from actual product.

We constantly strive to improve our products, therefore the specifications contained herein are subject to change without notice.

TurboTronic® and **Z-Line®**
are registered trademarks of **Z-GLOBAL B.V.B.A®**.