



dualchef

DUAL BASKET AIR FRYER

INSTRUCTION MANUAL



AIR FRYER OVEN TT-DAF7W

www.zline-world.com

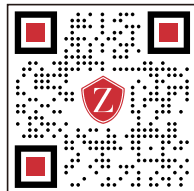

Thank you for buying **dualchef** - dual basket air fryer by **TurboTronic®**.

You will now be able to cook a wide assortment of food in a healthier manner – with little or no oil! The air fryer uses hot air, in combination with high-speed air circulation, and a top grill to prepare your dishes quickly and easily. The ingredients are heated from all sides, at once, and there is no need to add oil in most cases.

GENERAL DESCRIPTION

- A: Air inlet
- B: Control panel
- C: Basket handle
- D: Door
- E: Vent windows
- F: Power cord

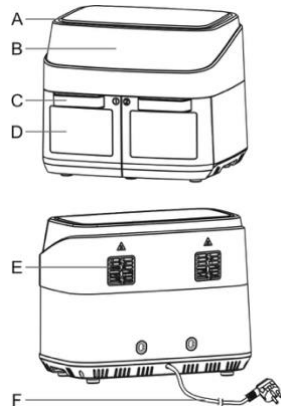

ACCESSORIES IN THE PACKAGE:



Small Mesh basket
235x170mm



Small oil tray
235x170mm



Small rack
235x170mm

SMALL
accessories

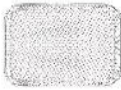

Big Mesh basket
235x357mm



Big oil tray
235x357mm



Big rack
235x357mm

BIG
accessories

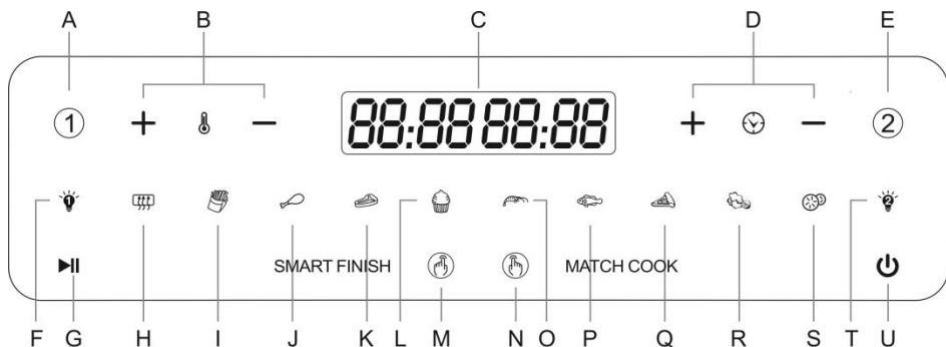

A: Zone 1

B: Temperature Plus/Minus
C: Time/ Temperature Display
D: Time Plus/Minus

E: Zone 2

F: Lamp 1

G: Start/Pause

H: Pre-Heat

I: French Fries

J: Drumsticks

K: Steak

L: Cake

M: Smart Finish

N: Match Cook

O: Shrimp

P: Fish

Q: Pizza

R: Vegetable

S: Dehydrate

T: Lamp 2

U: On/Off

Removable separation zone
making the inside as a
XXL 12-Liter capacity.



2 independent baskets
5.5L zones Lets you cook
2 foods, 2 ways at the same time.



NOTE :When the middle partition needs to be removed or installed, the machine is moved outward first,the handle of door should be as shown on the right , so that there is enough space to remove or install the partition.

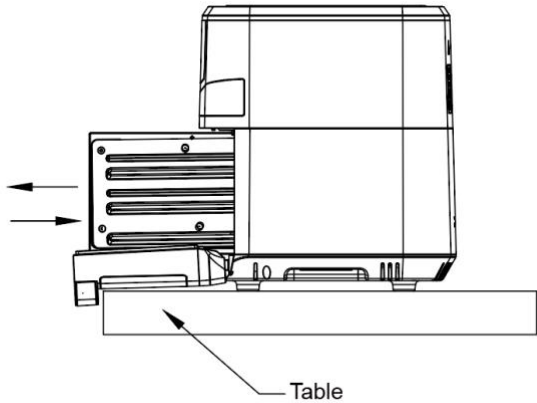

IMPORTANT INFORMATION

PLEASE READ THIS USER MANUAL CAREFULLY BEFORE THE USE OF THE APPLIANCE AND KEEP IT SAFELY FOR FUTURE REFERENCE.

Danger





- Never immerse the housing, which contains electrical components and the heating elements, in water and rinse it under the tap.
- Do not let any water or other liquid enter the appliance in order to prevent electric shock.
- Always put the ingredients to be fried in the tray, so as to prevent it from coming into contact with the heating elements.
- Do not cover the air inlet and the air exhaust openings while the appliance is operating.
- Do not fill the frying tray with oil as this may cause a fire hazard.
- Never touch the inside of the appliance while it is operating.
- Check whether the voltage indicated on the appliance corresponds to the local mains voltage in your country before you connect the appliance.
- Do not use the appliance if the plug, the power cord or the appliance itself is damaged.
- If the power cord is damaged, you must have it replaced at a service center authorized by similarly qualified persons in order to avoid a hazard.
- This appliance is not suitable for children or people who are either physically or mentally handicapped or those who lack experience and knowledge. If you want anyone else to use the appliance, that person should be properly guided on its use.
- Keep the appliance and its mains cord out of the reach of children when the appliance is switched on or is cooling down.
- Keep the main cord away from hot surfaces.
- Do not plug in the appliance or operate the control panel with wet hands.

- Only connect the appliance to an earthed wall socket, and always make sure that the plug is inserted into the wall socket properly.
- Never connect this appliance to an external timer switch.
- Do not place the appliance on or near combustible materials such as a tablecloth or curtains.
- Do not place the appliance against a wall or against other appliances; Leave at least 10cm free space at the back and sides and 10cm free space above the appliance; Do not place anything on top of the appliance.
- Do not use the appliance for any purpose other than what described in this manual.
- Do not let the appliance have an unattended operation.
- During hot air frying, hot steam is released through the air exhaust openings; Keep your hands and face at a safe distance from the steam and the air exhaust openings; Be careful of hot steam and hot air when you remove the frying tray from the appliance.
- The surface below the appliance may become hot during use.
- Immediately unplug the appliance if you see dark smoke coming out of the appliance; Wait for the smoke emission to stop before you remove the frying tray from the appliance.



Caution

- Place the appliance on a horizontal and stable surface.
- Always unplug the appliance after use.
- Let the appliance cool down for about 30 minutes before you handle or clean it.
- Remove burnt remnants.
- This appliance is intended for normal household use only. It is neither intended for use in environments such as staff kitchens, offices, farms or other work environments, nor intended to be used by clients in hotels or other similar environments.
- If the appliance is used improperly or if it is not used according to the instructions in the user manual, the warranty becomes invalid and seller refuses any liability for any damage that may be caused.

	Indicates to read and review instructions to understand operation and use of product.
	Indicates the presence of a hazard that can cause personal injury, death or substantial property damage if the warning included with this symbol is ignored.
	Take care to avoid contact with hot surface. Always use hand protection to avoid burns.
	For indoor and household use only.

PRIOR TO THE FIRST USE

1. Remove all packing materials.
2. Remove any stickers or labels from the appliance, other than the rating label.
3. Thoroughly clean the frying tray, with hot water and some liquid washing soap using a non-abrasive sponge.

Note: You can also clean these parts in the dishwasher.

4. Wipe the inside and outside of the appliance with a moist cloth.

PREPARING FOR USE

1. Place the appliance on a stable, horizontal, and heat-resistant surface.
2. Place the crisper rack in the frying tray properly.

Do not fill the frying tray with oil or any other liquid.

Do not put anything on top of the appliance. This disrupts the airflow and affects the air-frying result.





USING THE APPLIANCE

1. Power on



There is a BEEP sound when you plug the appliance in. The Power Button  will illuminate in RED.



2. Menu selection/Temperature/Time

Zone1 or Zone2 works individually.

Plug in, it is at the standby mode. press , Then press  or , select cooking function. you can adjust the time and temperature freely by using Time +/- and Temperature +/- button. You can also press any function icon to cook different food. then press  unit start to work.

Zone1 and Zone2 works at the same time.

1). Plug in, it is at the standby mode. press , Then press , select cooking function. you can adjust the time and temperature freely by using Time +/- and Temperature +/- button. You can also press any function icon to cook different food.

2). After finish  function, press  and select cooking function. you can adjust the time and temperature freely by using Time +/- and Temperature +/-





button. You can also press any function icon to cook different food.

3). After finish above program then press  unit start to work. Every function has its own default time and temperature (As shown in the table). Customer can adjust the time and temperature freely by using Time +/- and Temperature +/- button.

The temperature control range is 50-200°C, every click on the + / - temperature will increase or reduce 10°C. At 200°C, , press the "+", will loop back to a temperature of 50°C, press the "-" at 50°C temperature will cycle back to 200°C. In the process of temperature control, temperature digital display will flicker on the screen (not flashing during working), after flickering 3 times, the temperature has been done of setting;

The adjusting time range is 1 to 60 mins. every click on the + / - time will increase or reduce 1 min. At 60 min if you press "+", the time will cycle back to 01 min, At 01 min, if you press "-", the temperature will cycle back to 60 min. In the process of time control, time digital display will flicker on the screen (not flashing during working), after flickering 3 times, the time has been done of setting.

3. Start, pause/stop

After select function, set the right time and right temperature, press , the  start to flicker, after BEEPS sounds, machine start to work. During the machine working, press , after BEEPS sounds, machine stop working, 

stop flickering. During the machine working, press , after BEEPS, machine stop working, and machine back to standby mode.

Noted:

(1). During working, you can take frying tray out, stop working, and you can check cooking result or add more food, machine continue to work on the program if pull in the frying tray.

4. End of program

Heating element stop working when working time is done, show 00 min, motor continues to work, buzzer warning. motor continues to work 1 min, cooling machine, then machine enter the standby mode.

SMART FINISH

SMART FINISH



MATCH COOK

Cooking 2 foods using 2 different functions, temps or cook times and finish at the same time.

Step1: Program Zone1

Place food in basket

press **1**

Select a cooking function

Step2: Program Zone2

Place food in basket

Press **2**

Select a cooking function

Step3: Begin cooking

Select SYNC FINISH

Press **▶||** to begin cooking

MATCH COOK

SMART FINISH



MATCH COOK

Cooking the same food in each zone

Set Zone 1 and use DUAL COOK to automatically match settings to zone 2.











Step1: Select DUAL COOK

Step2: Select a cooking function

Press **▶||** to begin cooking.

MENU TABLE

program logistics

	menu	Default time (min)	Default temperature (°C)
function	 Pre-heat	3	180
	 French fries	18	200
	 Drumsticks	20	200
	 Steak	12	180
	 Cake	25	160
	 Shrimp	8	180
	 Fish	10	180
	 Pizza	20	180
	 Vegetable	10	160
	 Dehydrate	360(Adjustable time: 0.5 hour to 24 hours)	60

⚠ Caution: Do not touch the pan during and about 30mins after use, as it gets very hot.
Only hold the pan by the handle.

Operation step

1. Put the mains plug in an earthed wall socket.
2. Put the ingredients into the frying tray.
3. Put the frying tray in the right position; Choose function from menu and press START/PAUSE to start cooking.

4. Screen display

It will show temperature and time. Temperature is the setting temperature and time is remaining working time.

The function we have selected is flicker.

5. Some ingredients require shaking halfway through the preparation time (see section 'Settings' in this chapter). To shake the ingredients, you can pull the frying tray out of the appliance by the handle and shake it. Then, you can slide the frying tray back into the air fryer.

6. When you hear the timer bell, the set preparation time has elapsed. You can pull the pan out of the appliance and place it on a heat-resistant surface.

7. Check whether the ingredients are ready.

If the ingredients are not ready yet, you can simply slide the frying tray back into the appliance and cook it extra minutes.

8. Empty the tray into a bowl or onto a plate.

Tip: *To remove large or fragile ingredients, you can use a pair of tongs to lift the ingredients out of the tray.*

9. When a batch of ingredients is ready, the air fryer is instantly ready for preparing another batch.

Note: When you use the Air Fryer for the first time, a slight smoke or odor may be emitted. This is normal and will soon disappear. It is essential to ensure that there is sufficient ventilation around the Air Fryer.

Settings

Apart from the preset menu, you also can use this air fryer to make other food by setting the time and temperature. This table below helps you to select the basic settings for the ingredients you want to prepare.

Note: *Keep in mind that these settings are only for reference. As ingredients differ in origin, size, shape and brand, we cannot guarantee the best setting for your ingredients.*

Because the Rapid Air Technology instantly reheats the air inside the appliance, pulling the frying tray briefly out of the appliance during hot air frying barely disturbs process.

Cooking Tips

Air Fryer and Parts will become hot during the cooking process.

Do not over fill Fry tray with foods.

Do not pack foods into Fry tray.

Using Oil

Adding a small amount of oil to food can make them crispier.

Oil sprays are good for applying small amounts of oil evenly to food.

Food Tips

You can air fry frozen food that can be baked in the oven.

To make cakes, hand-pies, or any foods with filling or batter, you can place foods in heat-safe container and put that in Fry Tray.

Pat dry foods with marinades before adding to Fry Tray.

Reheating Foods

Simply set temperature to 150°C for up to 10 minutes.

COOKING GUIDE – Note: these settings are a guide. As ingredients differ in size shape and brand, you may need to adjust cooking times and temperatures.

Note: *It is better to add 3 minutes to the preparation time before you start frying if the appliance is cold.*

CLEANING

Clean the appliance after every use.

The frying tray, and the inside of the appliance have a non-stick coating. Do not use metal kitchen utensils or abrasive cleaning materials to clean them, as this may damage the non-stick coating.

1. Remove the mains plug from the wall socket and let the appliance cool down.

Note: *Remove the frying tray to let the air fryer cool down more quickly.*

2. Wipe the outside of the appliance with a moist cloth.

3. Clean the frying tray with hot water, some washing liquid soap and a non-abrasive sponge.

You can use a washing liquid to remove any remaining dirt.

Note: *The frying tray is dishwasher-proof.*

Tip: If dirt is stuck to the crisper rack or at the bottom of the frying tray, you can fill the frying tray with hot water and some washing liquid soap, put the crisper rack in the frying tray, and let the frying tray and the crisper rack soak for approximately 10 minutes.

1. Clean the inside of the appliance with hot water and a non-abrasive sponge.

2. Clean the heating element with a cleaning brush to remove any food residues.

STORAGE

1. Unplug the appliance and let it cool down.

2. Make sure all parts are clean and dry.

Air Fry Cooking Chart

INGREDIENT	AMOUNT PER ZONE	PREPARATION
VEGETABLES		
Asparagus	1 bunch	Whole, stems trimmed

Beets	6-7 small	Whole
Bell peppers (for roasting)	3 small peppers	Whole
Broccoli	1 head	Cut in 1-inch florets
Brussels sprouts	1 lb.	Cut in half, stem removed
Brussels squash	1 1/2lbs	Cut in 1-2-inch pieces
Carrots	1 lb.	Peeled, cut in 1/2-inch pieces
Cauliflower	1 head	Cut in 1-inch florets
Corn on the cob	2 ears, cut in half	Husks removed
Green beans	1 bag (12oz)	Trimmed
Kale (for chips)	5 cups, packed	Torn in pieces, stem removed
Mushrooms	8 oz	Rinsed, cut in quarters
Potatoes, russet	1 1/2 lbs. 1 lb. 1 lb. 3 whole (6-8oz)	Cut in 1-inch wedges Hand-cut fries*, thin Hand-cut fries*, thick Pierced with fork 3 times
Potatoes, sweet	1 1/2 lbs. 3 whole (6-8oz)	Cut in 1-inch chunks Pierced with fork 3 times
Zucchini	1 lb.	Cut in quarters lengthwise, then cut in 1-inch pieces

POULTRY

Chicken breasts	2 breasts 4 breasts	Bone in Boneless
Chicken thighs	2 thighs 4 thighs	Bone in Boneless
Chicken wings	2 lbs.	Drumettes & flats

FISH&SEAFOOD

Crab cakes	2 cakes (6-8 oz each)	None
Lobster tails	4 tails (3-4 oz each)	Whole
Salmon fillets	3 fillets (4 oz each)	None
Shrimp	1 lb.	Whole, peeled, tails on

TOSS IN OIL	TEMP(°C)	SINGLE ZONE	DUALZONE
-------------	----------	-------------	----------

2 tsp	200	8-12 mins	20-25 mins
-------	-----	-----------	------------

None	200	30-35 mins	35-40 mins
None	200	10-15 mins	15-20 mins
1 Tbsp	200	8-10 mins	15-17 mins
1 Tbsp	200	15-20 mins	20-25 mins
1 Tbsp	200	20-25 mins	35-40 mins
1 Tbsp	200	13-16 mins	25-30 mins
2 Tbsp	200	17-20 mins	20-25 mins
1 Tbsp	200	12-15 mins	18-20 mins
1 Tbsp	200	8-10 mins	10-15 mins
None	200	7-9 mins	15-20 mins
1 Tbsp	200	7-9 mins	13-15 mins
1 Tbsp	200	20-22 mins	35-38 mins
1/2-3 Tbsp, canola	200	20-24 mins	30-35 mins
1/2-3 Tbsp, canola	200	19-24 mins	35-40 mins
None	200	30-35 mins	37-40 mins
1 Tbsp	200	15-20 mins	30-35 mins
None	200	36-42 mins	40-45 mins
1 Tbsp	200	15-18 mins	25-28 mins

Brushed with oil	200	25-30 mins	30-35 mins
Brushed with oil		22-24 mins	25-28 mins
Brushed with oil	200	22-28 mins	26-29 mins
Brushed with oil		18-22 mins	25-28 mins
1 Tbsp	200	18-22 mins	43-47 mins

Brushed with oil	200	5-10 mins	10-13 mins
None	200	5-8 mins	15-18 mins
Brushed with oil	200	7-12 mins	13-17 mins
1 Tbsp	200	7-10 mins	10-13 mins

Air Fry Cooking Chart, continued

INGREDIENT	AMOUNT PER ZONE	PREPARATION
------------	-----------------	-------------

BEEF

Burgers	2 quarter-pound patties, 80% lean	1/2 inch thick
---------	-----------------------------------	----------------

Steaks	2 steaks (8 oz each)	Whole
--------	----------------------	-------

PORK

Bacon	3 strips, cut in half	None
Pork chops	2 thick-cut, bone-in chops (10-12 oz each) 2 boneless chops (8 oz each)	Bone in Boneless
Pork tenderloins	1 lb.	None
Sausages	5 assuaged	None

FROZEN FOODS

Chicken cutlets	3 cutlets	None
Chicken nuggets	1 box (12 oz)	None
Fish fillets	1 box (6 fillets)	None
Fish sticks	18 fish sticks (11 oz)	None
French fries	1 lb.	None
French fries	1 lbs.	None
Mozzarella sticks	1 box (11 oz)	None
Pot stickers	2 bags (10.5 oz)	None
Pizza rolls	1 bag (20 oz,40 count)	None
Popcorn shrimp	1 box (14-16 oz)	None
Sweet potato fries	1 lb.	None
Tater tots	1 lb.	None
Onion Rings	10 oz	None

TOSS IN OIL	TEMP(°C)	SINGLE ZONE	DUALZONE
--------------------	-----------------	--------------------	-----------------

Brushed with oil	200	8-10mins	10-13mins
Brushed with oil	200	10-20mins	14-18mins

None	170	8-10mins	9-12mins
Brushed with oil Brushed with oil	200 200	15-17mins 14-17mins	23-27mins 17-20mins
Brushed with oil	190	15-20mins	20-25mins
None	200	7-10mins	17-22mins

None	200	18-21mins	20-25mins
None	200	10-13mins	18-21mins
None	200	14-16mins	17-22mins
None	200	10-13mins	16-19mins
None	200	18-22mins	28-32mins
None	200	32-36mins	50-55mins
None	190	8-10mins	10-12mins
1 Tbsp	200	12-14mins	16-18mins
None	200	12-15mins	15-18mins
None	200	9-11mins	14-18mins
None	200	20-22mins	30-32mins
None	190	18-22mins	25-27mins
None	190	13-16mins	18-22mins

Dehydrate Chart

INGREDIENT	PREPARATION
FRUITES&VEGETABLES	
Apples	Cored, cut in 1/8-inch slices, rinsed in lemon water, patted dry
Asparagus	Cut in 1-inch pieces, blanched
Bananas	Peeled, cut in 3/8-inch slices

Beets	Peeled, cut in 1/8-inch slices
Eggplant	Peeled, cut in 1/4-inch slices, blanched
Fresh herbs	Rinsed, patted dry, stems removed
Ginger root	cut in 3/8-inch slices
Mangoes	Peeled, cut in 3/8-inch slices, pit removed
Mushrooms	Cleaned with soft brush (do not wash)
Pineapple	Peeled, cut in 3/8-1/2-inch slices
Strawberries	Cut in half or in 1/2-inch slices
Tomatoes	Cut in 3/8-inch slices or grated; steam if planning to rehydrate



MEAT, POULTRY, FISH

Beef jerky	Cut in 1/4-inch slices, marinated overnight
Chicken jerky	Cut in 1/4-inch slices, marinated overnight
Turkey jerky	Cut in 1/4-inch slices, marinated overnight
Salmon jerky	Cut in 1/4-inch slices, marinated overnight

TEMP(°C)	SINGLE ZONE	DUALZONE
----------	-------------	----------

TIMES ARE THE SAME FOR BOTH ZONES

60	7-8 hours
60	6-8 hours
60	8-10 hours
60	6-8 hours
60	6-8 hours
60	4 hours
60	6 hours
60	6-8 hours
60	6-8 hours
60	6-8 hours
60	6-8 hours
60	6-8 hours

70	5-7 hours
70	5-7 hours
70	5-7 hours
70	3-5 hours

Using DualZone Technology: SYNC FINISH

CHOOSE ANY TWO

ADD ONE RECIPE PER ZONE

RECIPE	AMOUNT
Crab Cakes	2 crab cakes
Balsamic Roasted Tomatoes	2 pints cherry tomatoes
Maple Sage Pork Chops	2-3 boneless pork chops (4 oz each)
Cajun Russet Potatoes	4 medium potatoes, diced
Classic Meatloaf	1 lb. meatloaf mix (beef, pork, veal)
Green Beans with Almonds	1 lb. green beans, ends trimmed
Miso Glazed Salmon	3 salmon fillets (6 oz each)
Honey Hazelnut Brussels Sprouts	1 lb. Brussels sprouted, cut in half
Buffalo Chicken Thighs	4 boneless skin-on chicken thighs (4-5 oz each)
Plants Based "Meat" Burger	1 lb. plant-based ground "meat" (4 4-oz patties)
Mediterranean	1 head cauliflower, cut in 1/2-inch florets
French Fries	1 lb. French fries



**SET BOTH ZONES
AND USE SYNC
FINISH**

MIX OR COMBINE THESE INGREDIENTS	FUNCTION	TEMP/TIME
Brush with melted butter	Air Fry	195°C/15 mins

1/2 cup balsamic vinegar 1 Tbsp canola oil	Roast	195°C/15 mins
2 Tbsp canola oil 2 Tbsp Cajun seasoning	Roast	195°C/17-20 mins
1/4 cup ketchup, 1/4 cup yellow mustard, 1 egg, 1/2 cup panko breadcrumbs, 1/4cup Parmesan cheese	Air Fry	200°C/30 mins
2 Tbsp canola oil 1/2cup sliced almonds	Air Fry	165°C/35 mins
2 Tbsp canola oil 1/2cup sliced almonds	Air Fry	195°C/15 mins
2 Tbsp miso paste, 1 teaspoon canola oil Rub onto salmon	Air Fry	195°C/15 mins
2 Tbsp canola oil, 1/4 cup honey, 1/2 cup chopped hazelnuts	Air Fry	195°C/23 mins
1cup buffalo sauce, toss with chicken	Air Fry	200°C/27 mins
1Tbsp minced garlic, 1Tbsp minced onion	Air Fry	185°C/20 mins
1/2 cup tahini, 2 Tbsp canola oil	Air Fry	195°C/35 mins
Season as desired	Air Fry	200°C/30 mins

TROUBLESHOOTING

Problem	Possible cause	Solution
The air fryer does not work	The appliance is not plugged into the mains.	Put the mains plug in an earthed wall socket.
	You have not set the timer.	Turn the timer knob to the required preparation time to switch on the appliance.
Food not fully cooked	The amount of the ingredients in the Frying Tray is too much.	Put smaller batches of ingredients in the Frying Tray. Smaller batches are fried more evenly.
	The set temperature is too low.	Turn the temperature control knob to the required temperature setting (see section 'Settings').
	The preparation time is too short.	Turn the timer knob to the required preparation time (see section 'Settings').
The ingredients are fried unevenly in the air fryer.	Certain types of the ingredients need to be shaken halfway throughout the preparation time.	Ingredients that lie on the top of or across each other (e.g. fries) need to be shaken halfway throughout the preparation time (see section 'Settings').
Fried snacks are not crispy when they come out of the air fryer	You use a type of snack meant to be prepared in a traditional deep fryer.	Use oven snacks or lightly brush some oil onto the snacks for a crispier result.
Cannot slide the pan into the appliance properly.	There is too much food in the Frying Tray.	Do not fill the tray beyond the maximum amount indicated in the table on the earlier page.
White smoke comes out of the appliance	You are preparing greasy ingredients.	Note that the temperature is well-controlled to be under 180°C, when you fry greasy ingredients in the air fryer.

Problem	Possible cause	Solution
	The pan still contains greasy residues from the previous use.	White smoke is caused by grease heating up in the pan. Make sure you clean the pan properly after each use.
Fresh potato fries are fried unevenly in the air fryer.	You did not soak the potato sticks properly before you fried them.	Soak the potato sticks in a bowl of water for at least 30 minutes; take them out and dry them with kitchen paper.
	You did not use the right potato type.	Use fresh potatoes and make sure they stay firm during frying.
Fresh potato fries are not crispy when they come out of the air fryer.	The crispiness of the fries depends on the amount of oil and water in the fries.	Make sure you dry the potato sticks properly before you coat them with oil.
		Cut the potato into thinner sticks for a crispier result.
		Add slightly more oil for a crispier result.

DISPOSAL OF OLD ELECTRICAL APPLIANCES



The European directive 2002/96/EC on Waste Electrical and Electronic Equipment (WEEE), requires that old household electrical appliances must not be disposed of in the normal unsorted municipal waste stream. Old appliances must be collected separately in order to optimize the recovery and recycling of the materials they contain, and reduce the impact on human health and the environment.

The crossed out “wheeled bin” symbol on the product reminds you of your obligation, that when you dispose of the appliance, it must be separately collected.

Consumers should contact their local authority or retailer for information concerning the correct disposal of their old appliance.

LIMITED WARRANTY

Limited Warranty applies to purchases made from authorized retailers of **TurboTronic®**. **TurboTronic®** Warranty coverage applies to the original owner and to the original product only and is not transferable.

TurboTronic® warrants that the unit shall be free from defects in material and workmanship. Limited Warranty apply only when it is used under normal household conditions and maintained according to the requirements outlined in the Owner’s Guide, subject to the following conditions and exclusions:

ANY WARRANTY OR AFTER PURCHASE SERVICE, SHOULD BE WITH A THIRD-PARTY COMPANY, FROM WHICH YOU PURCHASED THE PRODUCT. TURBOTRONIC® PROVIDES THE WARRANTY ONLY TO OUR THIRD-PARTY SUPPLIERS. SINCE THIS PRODUCT IS NOT PURCHASED DIRECTLY FROM TURBOTRONIC® BUT THROUGH ONE OF OUR THIRD-PARTY SUPPLIERS, ANY ISSUE AFTER THE PURCHASE, CUSTOMER SERVICE OR RECEIVING THE WARRANTY SHOULD BE ONLY / DIRECTLY THROUGH THE THIRD-PARTY SUPPLIERS FROM WHICH YOU PURCHASED THE PRODUCT.

What is covered by this warranty?

1. The original unit and/or non-wearable parts deemed defective, in **TurboTronic®** sole discretion, will be repaired or replaced
2. **TurboTronic®** reserves the right to replace the unit with one of equal or greater value.

What is not covered by this warranty?

1. Normal wear and tear of wearable parts (such as blending vessels, lids, cups, blades, blender bases, removable pots, racks, pans, etc.), which require regular maintenance and/or replacement to ensure the proper functioning of your unit, are not covered by this warranty.
2. Any unit that has been tampered with or used for commercial purposes.
3. Damage caused by misuse, abuse, negligent handling, failure to perform required maintenance (e.g., failure to keep the well of the motor base clear of food spills and other debris), or damage due to mishandling in transit.
4. Consequential and incidental damages.
5. Defects caused by repair persons not authorized by **TurboTronic®**. These defects include damages caused in the process of shipping, altering, or repairing the **TurboTronic®** product (or any of its parts) when the repair is performed by a repair person not authorized by **TurboTronic®**.
6. Products purchased, used, or operated outside Europe.

Illustrations may differ from actual product.

We are constantly striving to improve our products, therefore the specifications contained herein are subject to change without notice.

TurboTronic® and **Z-Line®** are registered trademarks of **Z-GLOBAL B.V.B.A®**.

PRINTED IN PRC