

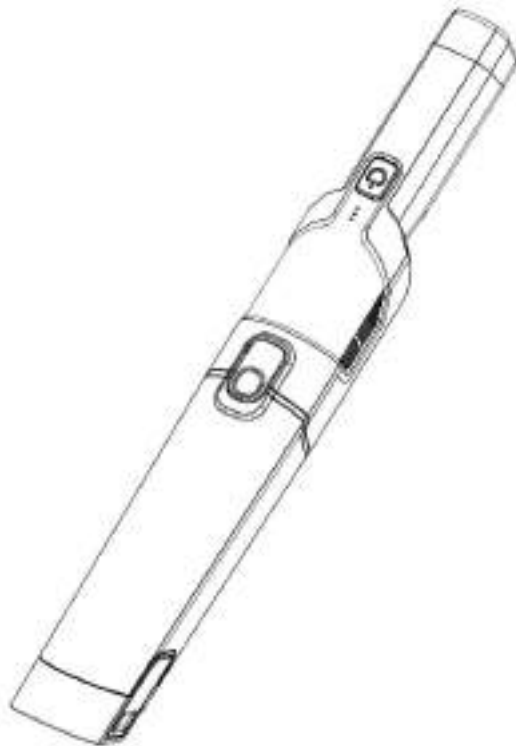

LUX500
Handheld Vacuums

Instruction Manual



TT-LUX500

www.zline-world.com

warning:

Please take care of the instruction for future use.

- Children must be supervised by an adult. Do not allow children to play with the vacuum cleaner
- This appliance is for family use only. Do not use outdoors
- When unplugging the charger, please hold the plug, do not pull the power cord
- Do not leave the vacuum cleaner when the power is on, so as not to cause harm
- If the power cord is damaged, it must be replaced by a maintenance worker. Do not replace without permission, so as not to cause harm
- The following objects are strictly prohibited, otherwise it will damage the vacuum cleaner or cause fire, causing harm to human body.
 - Do not absorb large or sharp objects, such as glass
 - Do not absorb reactive liquids (e.g. soluble, corrosive, detergent, etc.)
 - Do not absorb flammable or explosive objects, such as gasoline, alcohol...
- Always check equipment or charger for damage.
- If there is any damage to the airframe or other places, please do not continue to use. Do not open the device or charger without permission, and do not replace the power cord by yourself. Please send the machine to professional maintenance personnel for maintenance. Do not try to repair the machine by yourself to avoid injury
- Please pay special attention not to trip the power cord when charging the machine
- Keep power lines away from hot surfaces. (e.g. cooking utensils and other hot objects).
- Do not touch the charger or power cord with damp hands.
- When using a vacuum cleaner, do not aim the cleaner at people or animals.
- Please use the accessories provided.
- Please store this manual in a safe place.
- Please use the charger provided.
- Keep out of the hands of children and the elderly and infirm.
- If there is an overflow of inhaled liquid, please check whether the dust bucket is full, otherwise it will block the filter bag or seriously damage the vacuum cleaner.

Parts description

- 1, On/off switch
- 2, Charging indicator
- 3, dust cup button
- 4, Dust release button
- 5, Charging base
- 6, Crevice nozzle
- 7, Small brush
- 8, adaptor

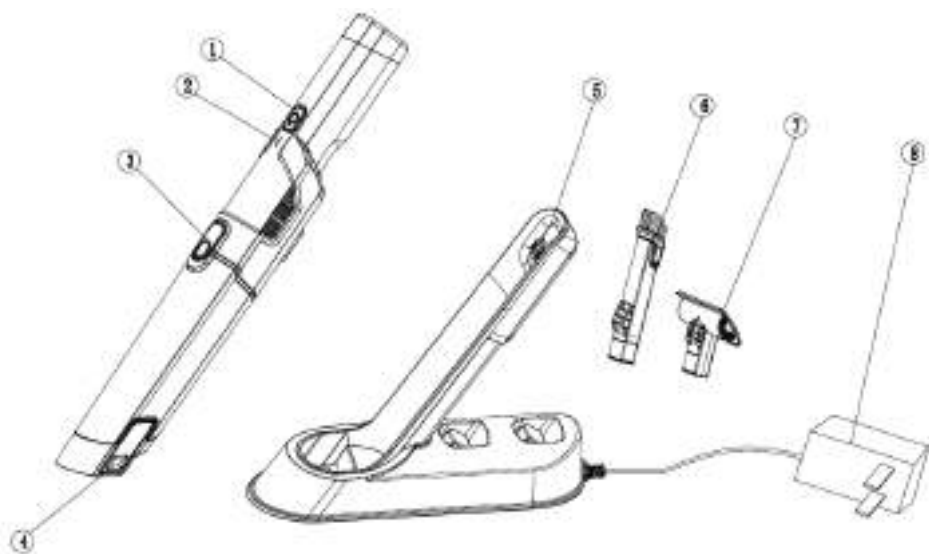

How to charge

Attention: the charging stand can be placed on a flat surface.

- 1 , Place the vacuum cleaner on the charging base
- 2 , Plug the charger into the socket.(make sure the machine is turned off before charging)
- 3 , When charging, the charging indicator lights is red, when it is full charged the light is blue.
- 4 , After charging, please unplug the charger.
- 5 , The charger may get hot during charging.

Important: please be sure to use the charger provided when purchasing to charge!

Charging indicator

- 1 , The indicator light is red color while charging
- 2 , The indicator light is blue color when full charged
- 3 , The indicator light is blue color when use the vacuum cleaner
- 4 , When the battery is running out, the red charging indicator flashes.
- 5 , When the battery is completely exhausted, the charging indicator will go off.

Use and function

Do not use this product while charging.

Please check whether there is **rarity** in the flat suction frequently. If there is a foreign body, it may scratch your floor.

- 1 , Insert crevice nozzle into main engine for cleaning table, car interior, corner, etc.

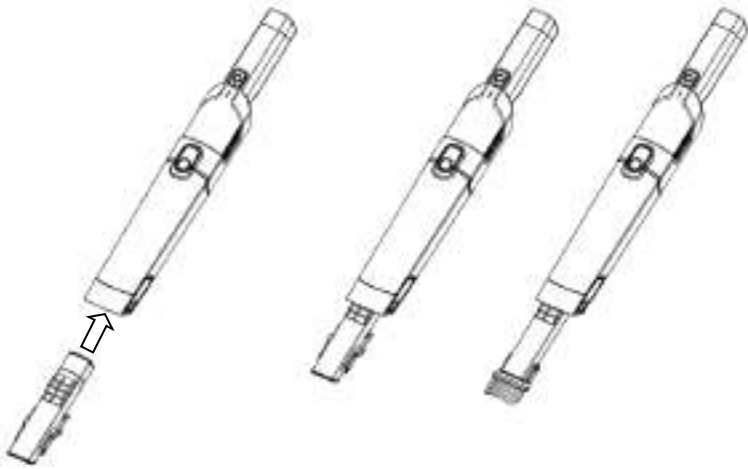

2. Insert the small brush into vacuum cleaner to cleaning sofa,carpet, ect

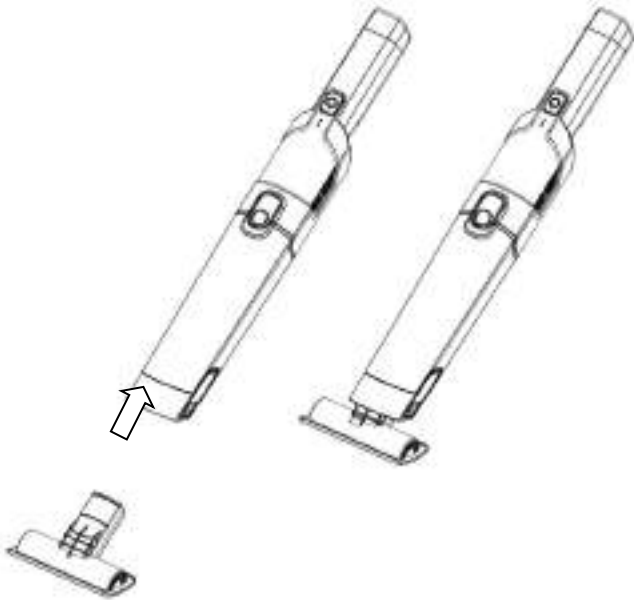

3 , Press the switch button to start up.

4 , Press the button again to control the speed

5, Press the switch button to turn off

Clean the dust cup

1, Press the lock of dust release button on both sides, take out the suction nozzle, and pour out the garbage

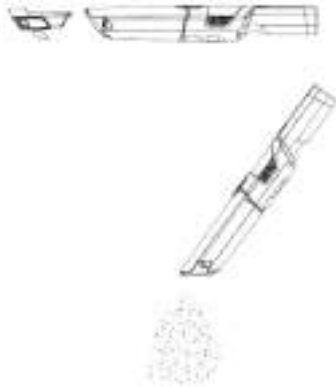

2, Press the dust cup button to remove dust cup

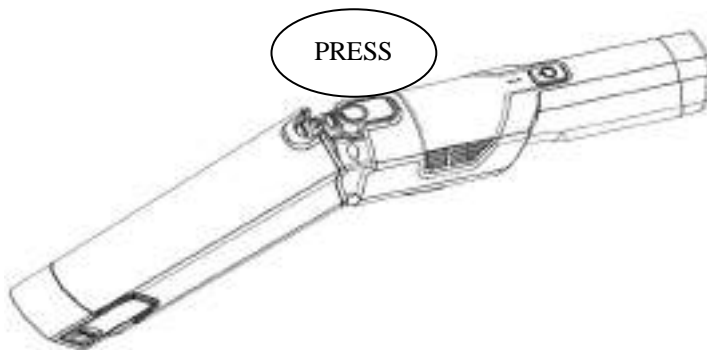

3 , Remove the filter inside

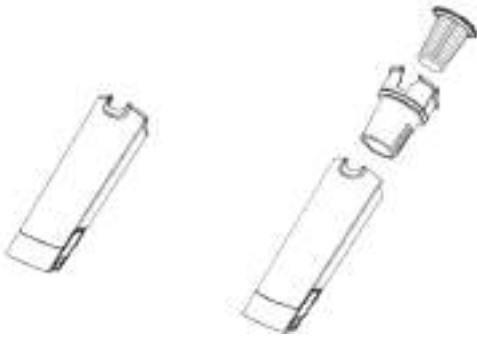

- 4 , Clean the filter and dust cup
- 5, Put the filter into dust cup



- 6 , Put the dust cup into the machine.

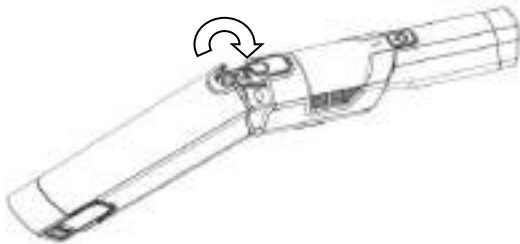

Important: make sure the filter and dust cup are completely dry before placing them in place.

How to dispose of the old battery

Remove the battery from the device before discarding it.

Do not put the discarded batteries with the daily garbage

Put together;The batteries should be sent to a local authority recycling center.

If you can't remove the battery yourself,

Your local recycling center will take it down.

Maintenance

When this product fails, please be sure to have professional repair.